

User Manual

Foldable Electric Scooter

(ENGLISH)

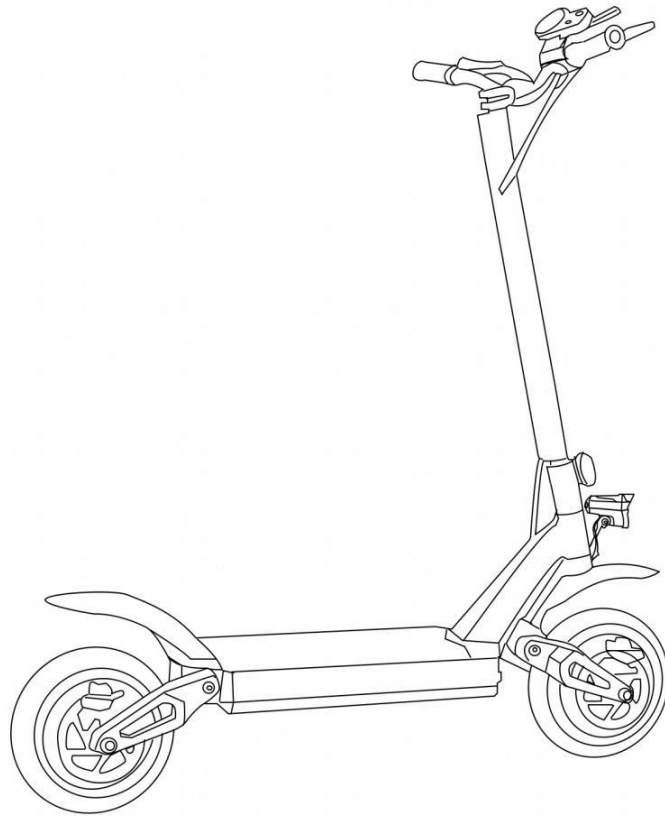

Read Me First

Dear user,

Thanks for purchasing this electric scooter! This electric scooter is an environmentally-friendly high-tech product. It is a new transport with excellent shock absorption, streamlined appearance, portability and flexibility, good riding comfortability, high safety and reliability features. Please kindly read the user manual carefully, so that you can understand the characteristics, technical parameters, correct use and maintenance, precautions and safe-sale services of this scooter well.

1. DO NOT use the scooter before learning about the User Manual and its performance.
2. DO NOT lend your scooter to anyone who cannot operate it, juveniles, pregnant women, or the disabled.
3. Please check carefully whether the braking system works well before driving the scooter.
4. Keep the charger in good ventilation and heat-dispersion during charging, do not charge scooter at high temperature.
5. Please make sure the screws of wheel are tightened well when replace motor or tire. Any loose screws of wheel may lead to big accident.
6. DO NOT disassemble or modify the circuit or parts of the scooter arbitrarily.
7. Please **put on appropriate protective clothing, such as helmets, knee pads, elbow pads, wrist.** We suggest you wear the best outdoor sport equipment.
8. Please power off scooter and stop to drive it if any abnormality of the scooter.
9. Images included in this user manual may be different from the scooter you received. The images are only for reference, subject to the actual scooter.
10. The performance and configuration of the scooter may be improved from time to time, subject to change without prior notice.

Safety Instructions

For adults use only!

Please abide by your local traffic regulations!

Do not speed up sharply! It is possible to fall down if you drive too fast or speed up sharply.

Do not drive when scooter with low battery. It is possible to fall down when battery run out.

Enjoy your riding!

Contents

Read Me First

Chapter 1 Product and Accessories.....	1
Chapter 2 Assembly Instructions.....	4
Chapter 3 Display Instructions and Remote Control.....	4
Chapter 4 Folding Procedure	7
Chapter 5 Safety instructions.....	7
Chapter 6 Scooter Battery.....	12
Chapter 7 Scooter Maintenance.....	17
Chapter 8 Specification.....	19
Chapter 9 Trademark and Legal Description.....	20
Chapter 10 Warranty.....	20

Chapter 1 Product and Accessories

Regardless the user manual should be read and kept. When your scooter is transferred to someone else, Please forward the manual together. Unless you read and understand the contents of the user manual ,please do not use the electric scooter . Otherwise it will cause unnecessary harm.

1. What you will get after purchase

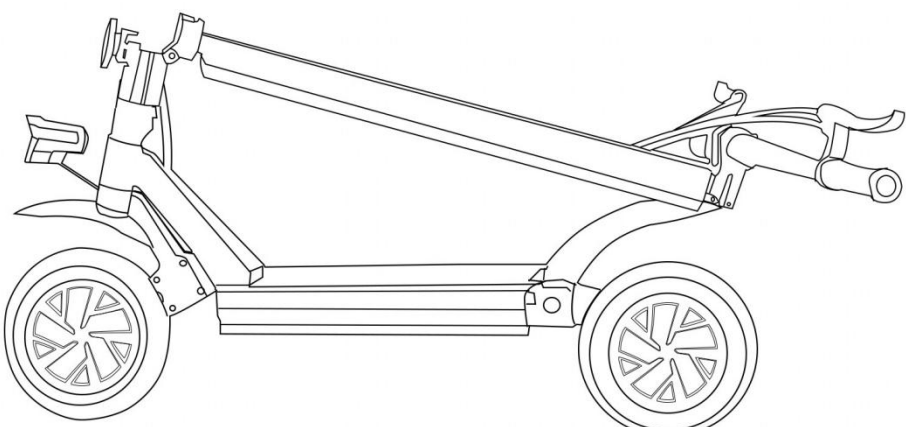
Product Body				
				
User Manual 1 pc	Charger 1 pc	Warranty card 1 pc	Tool 1 pc	Remote Control 2 pcs

2. Accessories Analysis And Dimension

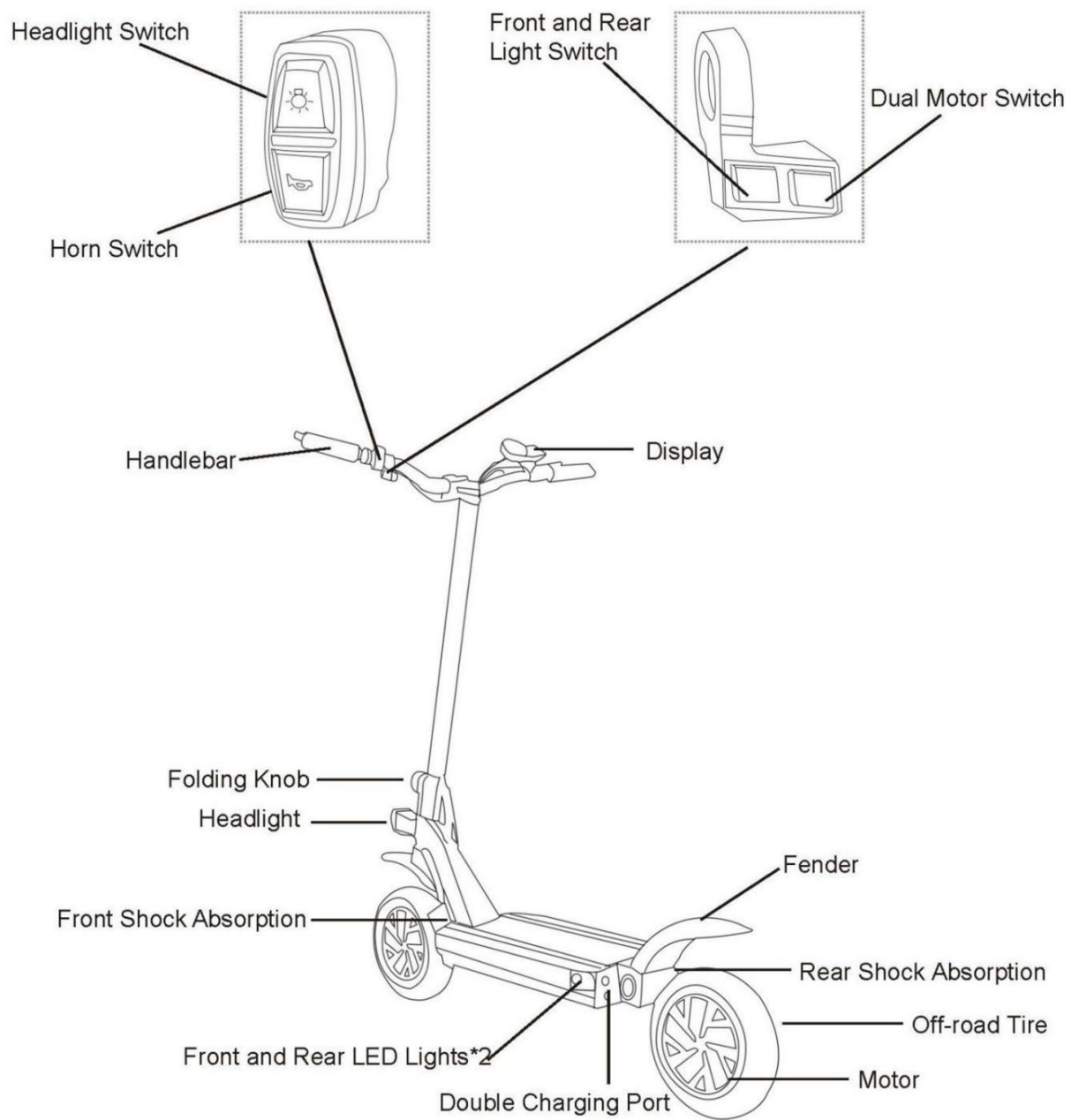

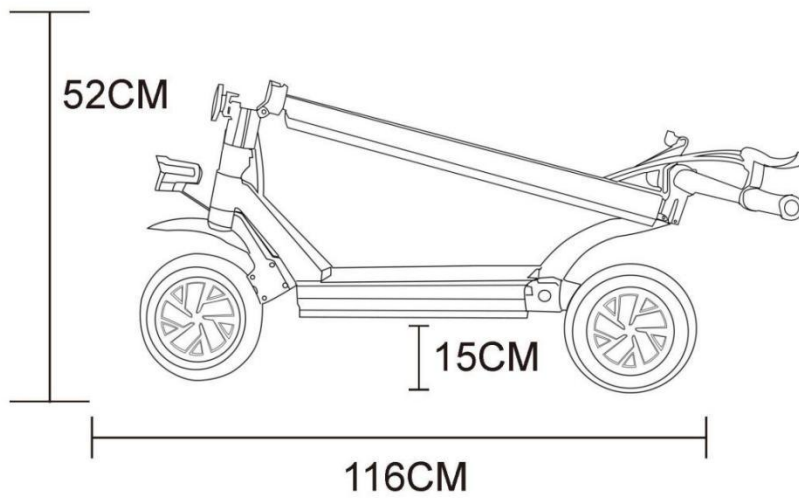
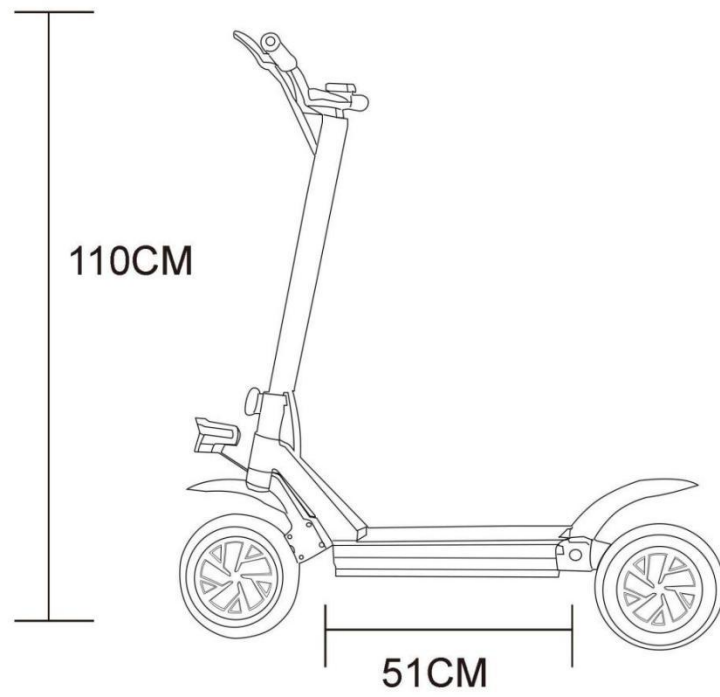

Chapter 2 Assembly Instructions

Electric scooter handlebar Assembly

1. Open the package,take out the charger,user manual and tool.
2. Take the scooter out carefully.
3. Put down the stand of scooter,make the scooter stand stable.
4. Unfold the scooter,and loose the two screws of steering rod.
5. Put the handlebar on steering rod well,please pay attention to the right position,and tight the screws well with tool.

Please kindly make sure the screws tightened well.

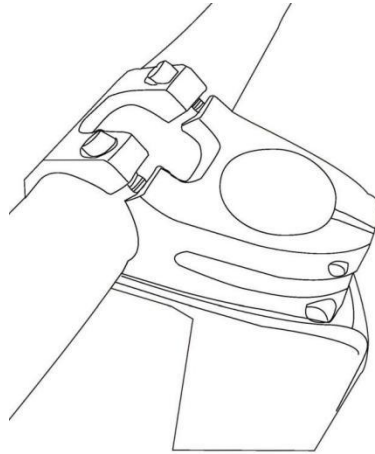

Chapter 3 Display Instructions and Remote Control

1. Display

Colorful round version is default, square version is optional.

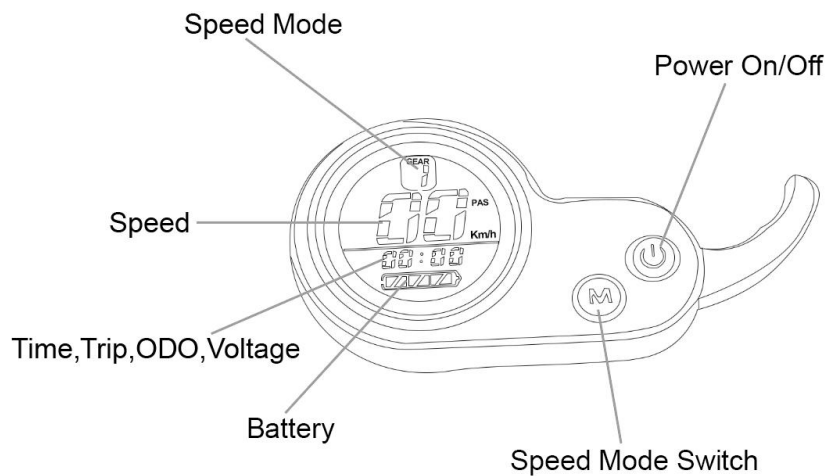

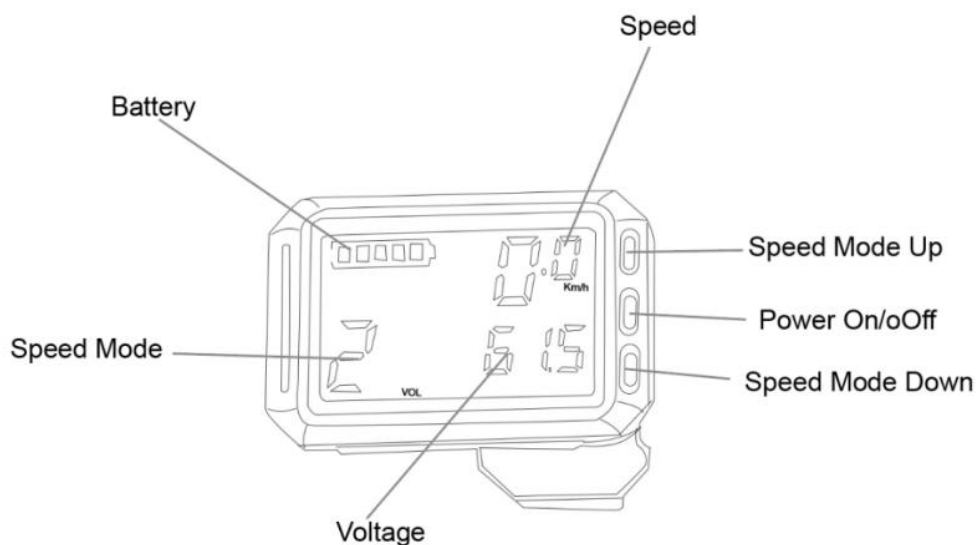

Display 1



Display 2

1)Button

There are two buttons on the Display, which are  Power button and  Function button. After Power on,the Display will show Battery,Speed and Speed model and so on.

2)Operation Instruction

Press Power button  a few seconds to turn on or off the power.

Display will power off if the scooter remains no signal in three minutes

Press the power button  shortly when the power on,display will show TRIP,ODO,VOL by turn, 00:00 means time, TRIP means DST trip distance.ODO means accumulated distance.VOL means battery voltage.

Press the speed button  shortly,three kind speed mode (Beginner Mode and Normal Speed Mode,High speed mode) will be switched by turn.

Press the speed button  a few seconds,DST trip distance will be reset to zero.

2.Remote Control

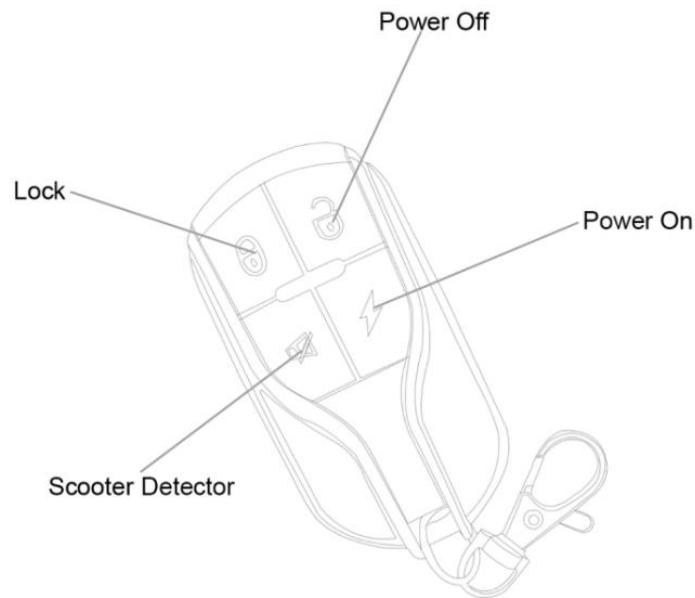

1)Button

Press off button: Power off scooter

Power on button: Power on scooter

Lock button: Lock scooter

Scooter Detector: Detect scooter

2)Operation Instruction

1) Press Power Off button to Power off scooter(Remark:You need use remote control to power on the scooter if you power off the scooter by remote control.The scooter can't be powered by pressing power button of Display a few seconds.If you power off scooter by pressing power button of Display a few seconds,you can also power on scooter by press power button of Display).

2) Press Power On button twice (you can hear one beep)to Power on scooter(Remark:if press twice,scooter still not power on,please press Power button of Display again).

3) Press Lock button to set scooter alarm.The scooter will make sound alarm if someone drive or move the scooter when the scooter is alarm,you need press the power off button to cancel the alarm.

4) Press Scooter Detector of remote control to find scooter,when you press the button,you can hear beep to find the scooter.

3.Single and Dual Motor Switch

The default mode(button is released) is single motor version,when the dual motor switch button is pressed,it will change to dual motor version.

Chapter 4 Folding Procedure

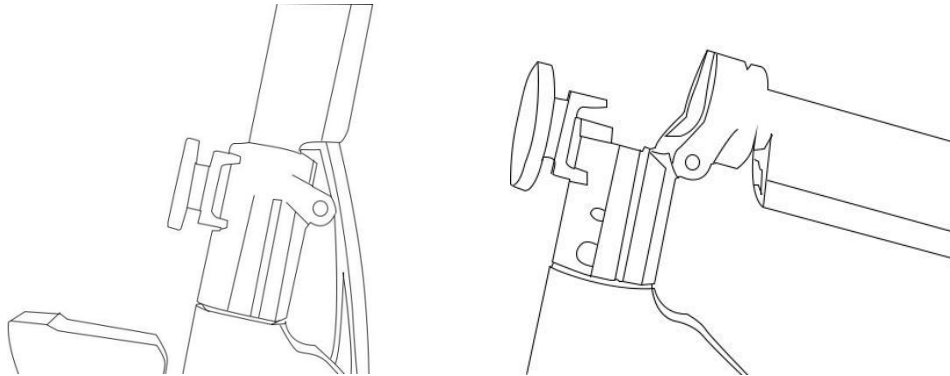

Scooter body folding/unfolding

3 seconds to quickly fold: Rotate the folding knob to take the folding parts out of the folding seat, and fold the steering rod down to complete the folding.

3 seconds to quickly unfold: Unfold the steering rod upward, tighten the folding knob, and fasten the folding knob to make folding parts in the folding seat well.

Chapter 5 Safety Instructions

Pre-drive inspection. Inspect the scooter before each driving. Do not use if any part is loose or damaged. Especially braking system.

1. Instructions

Do not allow any person to use the scooter unless the person has read the User Manual carefully .

Do not drive the scooter in hazardous atmospheres. Hazardous atmospheres are locations where fire or explosion hazards may exist due to flammable gases, vapors, liquids, dust, or fibers.

Wear a helmet, knee and elbow pad. Whenever you drive the scooter wear a helmet that fits properly with the chin strap in place. Use an approved bicycle or skateboard helmet that provides protection for the back of your head. Depending on driving conditions and your driving experience, consider using additional protective equipment such as gloves, eye protection, wrist guards, and knee pads. Wear footwear that protects your feet and provides adequate support and comfort.

Spot new drivers until they are comfortable with the basic operation of the scooter. All new

drivers should use the Beginner Mode. The safety of new drivers is your responsibility. Do not let new drivers operate the scooter outside of your direct supervision unless they have read the User Manual.

Avoid slippery surfaces, loose materials, steep slopes, and obstacles. If you cannot avoid a slippery surface, loose material, steep slope, or obstacle, then you must step off to move across it. Be especially careful when riding in confined spaces or near obstructions.

Use caution on slopes. Use caution when ascending, descending, or crossing slopes. Do not attempt to drive across any slopes with loose material or slippery surfaces. Instead, step off.

Watch those turns! Always turn slowly and with caution. Fast turns can lead to loss of control and falls.

Do not take risks. When you encounter a slope, uneven terrain, or other terrain feature with which you are not experienced or that makes you at all concerned about your safety, do not risk riding over it. Instead, step off .

Do not wear loose clothing that can catch in the tires and prevent proper steering.

No passengers. The scooter is for one driver. Do not drive double or carry any passengers. Do not carry a child in your arms or in a child carrier while riding. Expectant mothers should not drive the scooter.

Do not exceed the maximum weight limit (driver and all cargo) specified in the User Manual. Otherwise, you are at great risk of falling, injuring yourself and damaging the driver.

Never drive on stairs or through revolving doors. Riding on stairs, escalators and through revolving doors are extremely dangerous.

Do not step off a moving scooter. Always come to a stop before stepping off.

Do not drive in the dark. Do not drive the scooter in low visibility conditions without a light. To drive safely, you must be able to clearly see what is in front of you and you must be clearly visible to others.

Be alert. As with any other transportation device, you must be mentally alert to safely drive the scooter. Do not attempt to drive if you are ill or if you cannot comply fully with the instructions and warnings in the User Manual. Do not drive under the influence of alcohol or drugs.

Avoid distractions. Do not use a mobile phone, listen to headphones, or engage in any other activity that might distract you or interfere with your ability to monitor your surroundings while riding.

Be prepared to stop. Be especially careful when approaching or crossing intersections, driveways, corners, doorways, and other areas where you may need to slow down or stop to avoid motor vehicles, bicyclists, or pedestrians.

When riding, keep both hands on the Handlebar and both feet on scooter. Be relaxed. drive in

a relaxed position with your knees and elbows slightly bent. Do not attempt to carry any object in your hand(s). If you need to carry any object, use a cargo accessory that is recommended by scooter or a securely attached backpack with both shoulder straps in place.

Never restart and drive your scooter after it has indicated an empty Battery condition or performed a low Battery Safety Shutdown. The scooter may not have enough power to drive, especially if you demand a lot of power at once. If you restart and continue riding, you risk falling. Also, you may damage the Battery, resulting in reduced Battery life and capacity.

Riding on the road. The scooter is not intended or recommended for primary use on roads. If you must drive on the road, or must cross the road, be extremely careful. drive as far away from traffic as possible. Allow plenty of time for crossing roads. Remember, the Speed Limiter or an unexpected obstacle could slow your crossing. Check to make sure that riding on the road is allowed by law.

Carrying cargo. To carry cargo, use a cargo accessory that is recommended by scooter or a securely attached backpack with both shoulder straps in place. Do not place cargo (or any object) on the Metal Body. The total weight of any Handlebar payload plus any other attachments hanging from the Handlebar should not exceed 4.5 kg. Exceeding this limit interferes with the Scooter's balancing ability and could cause the scooter to accelerate on its own, risking injury and damage.

Leave a gap! Leave a gap between yourself and the Handlebar. Do not lean over or into the Handlebar. Leaning over or into the Handlebar dramatically increases the risk of loss of control, collisions and falls.

Do not drive the scooter if you suffer any impairment to balance.

The scooter has not been designed, tested, or approved as a medical device. You must be able to step on and off the scooter unassisted, which requires physical abilities similar to ascending and descending stairs without assistance and without holding the handrail.

Scooter recommends that you do not allow children to drive your scooter unless: (a) you have first learned to drive, so that you understand the care and skill required to drive safely; (b) the child has read this entire Manual and watched the entire Safety Video; and (c) you are satisfied that the child has the knowledge, maturity, and physical ability to drive safely without endangering him/herself or others. As a general rule, Scooter recommends that drivers be at least 16 years of age.

2.Improper Use

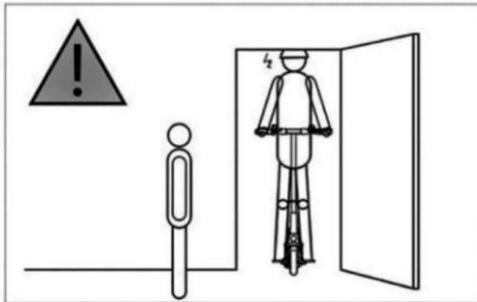

Watch out for overhead obstacles, such as the door frame or the elevator.



DO NOT pass irregular surfaces at a high speed.

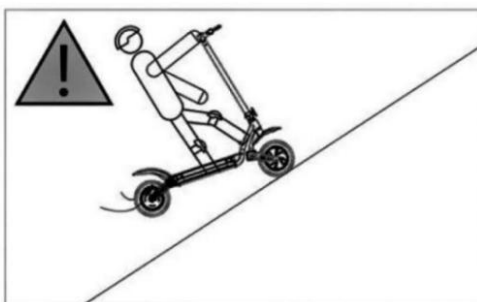

DO NOT ride on slopes larger than 20° for extended periods of time.

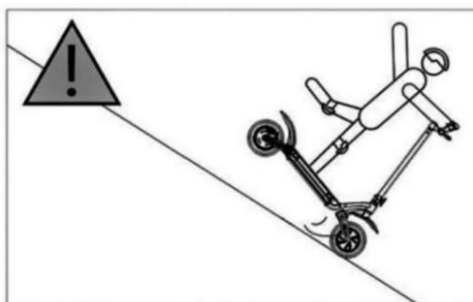

DO NOT accelerate while riding downhill. DO NOT use the front brake while riding at a high speed.

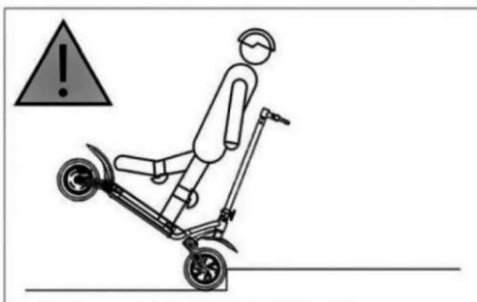

DO NOT go up/down steps or cross obstacles with the scooter.

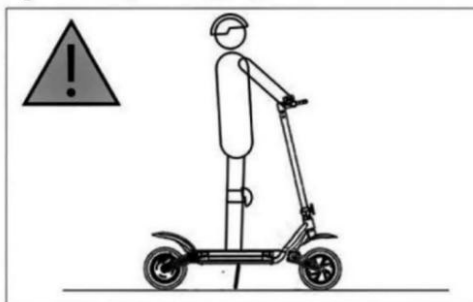

DO NOT stand on the footboard after the scooter is powered off and stops.



DO NOT ride in the rain

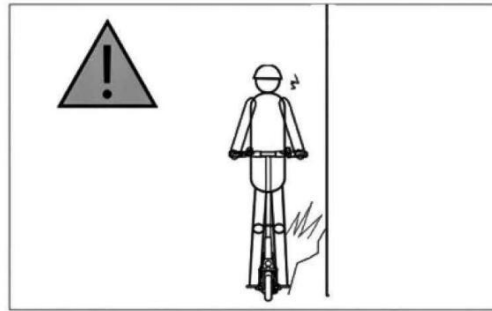

Avoid obstacles while riding

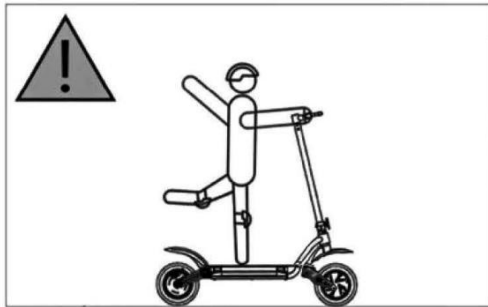

DO NOT ride with a single hand or foot

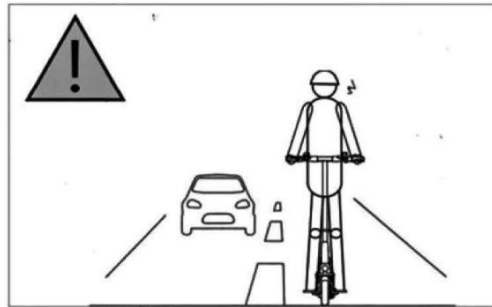

DO NOT ride on motor way

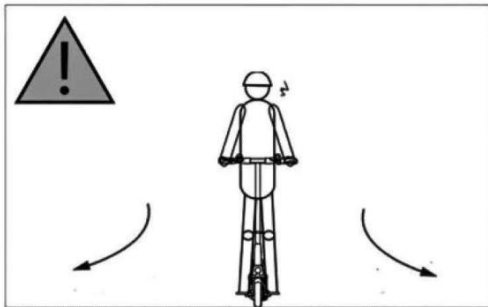

DO NOT rotate the handle violently while riding at a high speed

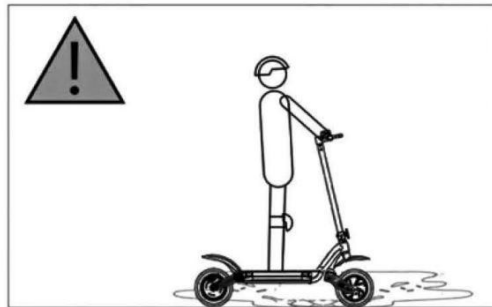

DO NOT ride in water deeper than 2cm



DO NOT ride with both hands leaving the handle

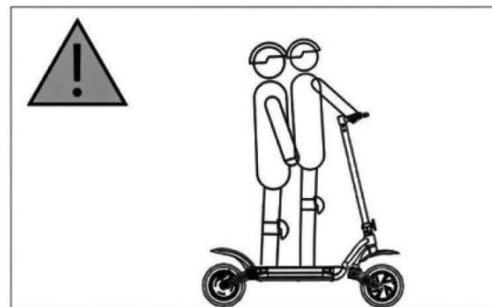

DO NOT carry passenger(s)

Chapter 6 Scooter Battery

1. Battery Safety

1) Do not use a Battery if the Battery casing is broken or if the Battery emits an unusual odor, smoke, or excessive heat or leaks any substance. Avoid contact with any substance seeping from the battery.

2) Keep out reach of children and pets. Exposure to Battery voltage could result in death or serious injury.

3) Unplug or disconnect the scooter from AC power before removing or attaching battery or performing any service. Never work on any part of the scooter when it is plugged into AC power. You risk serious bodily injury from electric shock as well as damage to the scooter.

4) The cells within the battery contain toxic substances. Do not attempt to open the battery. Do not insert any object into the battery or use any device to pry at the Battery casing. If you insert an object into any of the Battery ports or openings you could suffer electric shock, injury, burns, or cause a fire. Attempt to open the Battery casing will damage the casing and could release toxic and harmful substances, and will render the pack unusable.

5) Observe and follow all safety information on the warning label found on the battery.

6) Failure to charge the Battery could result in permanent damage to them. Left unplugged, the Battery could fully discharge over time, causing permanent damage.

7) **Use only dedicated charger** and never attempt to bypass or override their charging protection circuits.

8) Do not wash the scooter with a power washer or high pressure hose. Avoid getting water into the Charge Port. Always close the Charge Port Cover after charging. Avoid exposure to heavy downpours or extended periods of heavy rain (including during riding, storage, or while being transported). Clean with soap and water and a soft cloth. Make sure that the Charge Port is dry before you plug in the Power Cord. Failure to follow these instructions could expose you to electric shock, injury, burns, or cause a fire.

9) Do not submerge the Battery and scooter. If you suspect the Battery and scooter have been submerged or experienced water intrusion, contact your distributor. Until you receive further instructions, store the scooter upright, outdoors, and away from flammable objects. Do not attempt to remove the battery. Do not plug the Power Cord into the scooter. Failure to follow these instructions could expose you to electric shock, injury, burns, or cause a fire.

As with all rechargeable battery, do not charge near flammable materials.

2. Battery Specification

Model	52V 10.4Ah Lithium	52V 20.8Ah Lithium	60V 20.8Ah Lithium
Charging Time	4-5 hours	5-6 hours	6-7 hours
Before first use	5 hours	5 hours	5 hours
Recharge from empty	5 hours	6 hours	7 hours
Temperature Ranges			
Operating	-4°F - 104°F (-20°C - 40°C)		
Charging	32°F - 113°F (0 - 45°C)		
Storage and transport	-4°F - 104°F (-20°C - 40°C)		
General			
Dimensions	32*13*7cm	32*17*7 cm	32*17*7 cm
Battery weight(each)	3.6 ± 0.2Kg	5.9 ± 0.2Kg	6.4 ± 0.2Kg

3. Charging Battery

1) Charging

In order to maintain the best performance from your scooter Battery, fully charge the Battery for at least 5 hours once a month, or once every 5 hours of operation—whichever comes first. Charge your Battery only when they are within the specified charging temperature range.

Charging time varies depending on the following:

The battery has storage power, if the storage power is lower, the charging time will be longer. Do not charge scooter until to battery drop to deep cycle.

Temperature of the Battery—Battery that are too hot or too cold may not charge or may take much longer to charge. Battery charge most efficiently when they are close to the center of the recommended charging temperature range.

If storage temperature is below 32° F/0° C, do not charge your battery. Instead, bring them into a warm (above 50° F/10° C) environment for charging. Doing so will ensure optional battery life and performance.

Do not insert the Power Cord plug if the Charge Port, Power Cord, or AC Power outlet is wet.

2)To charge the battery

- 1)Put your scooter in a clean, dry place, within the recommended charging temperature range.
- 2)Open the Charge Cover on the charge port which on the back of your scooter.

3)Verify that the Charge Port, Power Cord, and AC Power outlet are clean, dry, and free of debris.

4)Plug the other end of the Power Cord into the Charge Port (The Green Indicator will turn Green).

4)Plug one end of the Power Cord (provided with your scooter) into a grounded AC outlet (100V–240V; 50Hz–60Hz). The Power Cord should be properly grounded (The Indicator of Charger will turn Red).

6)When charging completes, the Red Indicator will turn Green again.

NOTE: The scooter's charging system automatically prevents overcharging. But please do not make your scooter charging over 12 hours.

3)Unplugging the Scooter

When you are ready to use your scooter, remove the Power Cord, then close the Charge Port Cover as follows:

Disconnect the Power Cord from the grounded AC outlet.

Disconnect the Power Cord from the Charge Port on the scooter.

Store the charger.

Close the Charge Port Cover.

Always keep the Charge Port Cover closed, except when you are charging the scooter . Closing the Charge Port Cover prevents water, dirt, dust, and other contaminates from entering the Charge Port and causing damage to your scooter.

4)Instructions

1)Charge the lithium battery in a temperature range of 0° C to +45° C.

2)Maintain charge for 6-8 hours.

3)Use only dedicated charger to charge your scooter.

4)Local charger AC input voltage (100 ~ 240v).

5)Turn off the power before charging.

6)Make sure the charger connected to the scooter firstly, then plugging into the power.

Otherwise the charger hole may be broken.

7)Do not place the charger and board in wet place, must not be near the water.

8)**Notice:**Be away from other items no less than the 20cm, do not on the sofa, bed, carpet.Do not cover the charger and keep ventilation.

9)Do not place any weight or heavy object on the scooter and charger.

10) Prohibit unauthorized remove the scooter, or it will lose the warranty and cause the injure and the risk of electric.

11)The light is red when charging.The light turned to green when the battery is full,pull the plug within 2 hours.Do not continue to charge battery over specified time.

12) Please under the care of people when charging.

5) Charging Failures

If a failure is detected during charging, all charging will stop. Check the following:

If the Charge Indicator lights are off, check that AC power is present, and ensure the Power Cord is fully seated in the Charge Port.

If AC power is present and the Charge Indicator lights are off, it means the Charger have problem. Contact the Distributor of scooter.

Please do not use wrong charger in charging. Use only dedicated charger

Do not use one Charger charging several same scooter model, Charger always working may damage the Charger.

Do not disassemble charger. Contact the distributor of scooter when service or repair is required.

6) Surface Charge (Partial Charge)

Whenever you do not fully charge the scooter's battery, surface charge or partial charge may affect the accuracy of the Battery charge level display, causing it to show a higher charge level than actual battery level.

After you power on, check the Battery charge level display and then ride for at least three or four minutes and check the Battery charge level display again. If the Battery charge level display low percent or less vertical bars during this time, the battery have received only a surface charge. If necessary, plug the scooter back in and recharge.

4. How Temperature Affects Performance

The battery are usually significantly warmer than the air temperature due to heating that occurs electricity is delivered from them (while riding) and to them (while charging).

(1) Riding in Hot or Cold Temperatures

The battery will run at the highest efficiency when you operate them nearest the center of the recommended operating temperature range. As with all battery, less energy is available at low battery temperatures. You may not be able to travel the same distance when the battery are cold as when the battery are nearer to room temperature.

(2) Charging in Hot or Cold Temperatures

Your battery should be within the recommended charging temperature range prior to and during charging. For the recommended Battery charging temperature range, The battery will charge most efficiently when they are nearest the center of the recommended charging temperature range. If your battery are too hot or too cold, they may take longer to charge, or they may not charge at all.

5. Replacing Battery

Your scooter is powered by t one rechargeable Lithium Battery. With normal usage and proper maintenance, battery should last the equivalent of 800 to 1000 full charges. As your battery are near the end of their useful life, they need more frequent charging and your scooter's range will be reduced. To order replacement battery, contact your Distributor.

6. Battery Maintenance

Do not place the battery in a temperature higher than 50 C or in a low temperature below -20 C (for example, do not put the battery pack in a car exposed to the summer), do not put the battery pack into fire, otherwise it may cause the battery Failure, overheating, and even fire. For other battery maintenance precautions, see the battery pack nameplate located under the body.

Avoid completely exhausting the battery and recharging it. Try to use it as much as possible. This will greatly extend the battery life. In addition, when used at room temperature, the battery pack can achieve higher cruising range and performance; and if used in an environment below 0 C, battery life and performance will decrease. Typically, at -20 C, the cruising range may be only half or less at normal temperature. After the temperature rises, the battery's cruising range will recover.

Fully charged will exhaust its stored power after about 60~90 days of standby; if it is not fully charged, it will run out after about 20~40 days of standby. At this time, if it is not charged in time, it may cause the battery to be over-discharged and damaged. This damage is unrecoverable and will not be recharged due to damage caused by long periods of non-charging and will not be covered by the free warranty. (Note: Non-professionals are forbidden to disassemble the battery pack at will, otherwise serious safety accidents may result from electric shock or short circuit)

7. Storage Recommendations:

1).Storage the battery&charge at temperature of -20~ 35° C,low humidity and no corrosive gas atmosphere.

2).Long period Storage:

In case of long period storage(more than 3 months),storage lithium battery at temperature range of -10~20° C,low humidity, no corrosive gas atmosphere.

3)No press on the lithium battery.

Chapter 7 Scooter Maintenance

The scooter is designed to be virtually maintenance free. Make sure it is clean, all parts are installed and functioning properly, battery are charged, and Tires are properly inflated prior to riding. Never open the scooter, Display or Motor. These are not user-serviceable parts.

Before perform the following procedures, please confirmed that the scooter is powered off and unplugged. It is not safe to perform these procedures while the scooter is powered on or charging.

1. Lifting Your scooter

Watch out for your fingers! Lift the scooter: Don't use tires, fenders or wheel to lift scooter because your hands or fingers may be caught, resulting in personal injury. Using the appropriate technology to enhance security and load your scooter. We recommend to lift the scooter by two people working together.

2. Maintaining Tires and Wheels

The tire pressure should be proper. Higher pressure reduces suspension performance and traction, and increases risk of loss of control, collisions, and falls. Lower pressure reduces range and increases risk of damage to the Tire/ Wheel Assembly. Unequal pressure causes the scooter to turn in the direction of the lower pressure tire.

To ensure safe and efficient operation of your scooter, be sure to check Tires and Wheels regularly, especially if you have recently performed service on a Tire/Wheel Assembly.

3. Checking the Tire/Wheel Assembly

To check the Tires and Wheels:

- 1). Make sure the scooter is unplugged and powered off.
- 2). Check for Wheel wobble by grasping the Tire/Wheel Assembly and attempt to move it side-to-side. The Tire/Wheel Assembly should not move laterally. If you detect Wheel wobble, check the Wheel nut and tighten if necessary.

4. Tire Inflation Pressure

The Tires on the scooter provide suspension and traction. Both functions are affected by tire inflation pressure. Be sure to:

- 1) Make sure the scooter is unplugged and powered off.
- 2) Check tire inflation pressure regularly. Improperly inflated Tires will result in less than optimal range.
- 3) If tire inflation pressure in either Tire is not at the level stated in the "scooter Specifications" for your scooter model, inflate the Tire to the specified pressure.
- 4) Check that both Tires are inflated equally and are free of debris or contaminants.

5. Cleaning Your scooter

Do not clean the Mat or Tires with any specialized cleaners. Use of such products may reduce traction, increasing the risk of a fall.

To clean your scooter:

- 1) Make sure the scooter is unplugged and powered off.
- 2) Always close the Charge Port Cover after charging and prior to cleaning.
- 3) Gently clean your scooter with soap and water and a soft cloth.
- 4) Avoid Submerging Your scooter

Do not wash the scooter with a power washer or high pressure hose. Avoid getting water into the Charge Port. Always close the Charge Port Cover after charging. Avoid exposure to heavy downpours or extended periods of heavy rain (including during riding, storage, or when transporting). Clean with soap and water and a soft cloth. Make sure that the Charge Port is dry before you plug in the Power Cord. Failure to follow these instructions could expose you to electric shock, injury, burns, or cause a fire.

Do not submerge the battery or Metal Body in water. If you suspect the battery or Metal Body have been submerged or experienced water intrusion, contact your distributor. Until you receive further instructions, store the scooter upright, outdoors, and away from flammable objects. Do not attempt to remove the battery. Do not plug the Power Cord into the scooter. Failure to follow these instructions could expose you to electric shock, injury, burns, or cause a fire.

6. Servicing Your scooter

Always shut down your scooter and unplug the AC Power Cord before performing any maintenance or installing any part or accessory.

Do not attempt to open the scooter. There are no user-serviceable parts inside. By opening the scooter you risk electric shock injury. Also, you could void your limited warranty, damage your scooter, and render it unsafe to use.

Do not open the motor. There are no user-serviceable parts inside the motor. You could damage your scooter and render it unsafe to use.

Use only scooter-approved parts, fasteners, and accessories.

Wear safety glasses. Failure to do so could result in serious injury.

Chapter 8 Specification

Lithium Battery	52V 20.8 Ah	52V 20.8 Ah	60V 20.8 Ah
Battery Power	1081.6Wh	1081.6Wh	1248Wh
Motor Power	1000W (Single motor)	2000W (Dual Motor)	3600W(Dual Motor)
N.W/G.W	25kg/30kg	28kg/33kg	30kg/35kg
Speed (3 speed mode)	20-30-45 KM/H	20-35-50 KM/H	25-50-70 KM/H
Max. Mileage	50-60 KM	50-60 KM	60-70 KM
Charging Time	6-7 h	6-7 h	7-8 h (4-5 h for Dual Charging)
Max. climb capability	25-30 degree	35-40 degrees	45 degrees
Max Load	150 KG		
Waterproof Grade	IP 55		
Brake type	Front Rear independent 140mm single disc mechanical brake		
Display	Colorful Smart Display With USB Charging Port		
Tire	10 inch tire		
Material	7005 Aluminium Alloy		
Voltage	110 V-240 V, 50/60Hz		
Working temperature	0°C~40°C		
Size	Packing Size (cm)	120*30*60 CM	
	Opening Size (cm)	116*26*110 CM	
	Folding Size (cm)	116*26*52 CM	
	Applicable Age (years)	18-55	
	Applicable Height (cm)	150-200CM	
Riding Requirements	Applicable terrain	Hardened pavement, flat mud pavement, 35 degrees below the ramp, not higher than the 5CM steps, no more than 6CM of the channel.	

Chapter 9 Trademark and Legal Description

This User manual is applicable to all the scooter Series made by our company. You may find that some functions are different from what you ordered. It is normal because of different series. The content and technical specifications in this User Manual are valid when permitted to be printed. But our company has the right to alter and change technical specification or design without prior notification. And we will not assume any obligation.

This User Manual contains Images,function descriptions and instructions for use when printing. They are only for reference,it may be different from the scooter your purchased because of improvement of product features, design changes, etc from time to time. Some of the features,performance and configuration mentioned in this User Manual may not be available on your received scooter,subject to the real scooter.

Chapter 10 Warranty

Dear Customer:

Thanks for your purchasing our scooter!For service you well,after buying the scooter,please read carefully and fill the warranty card well and keep it.

CONDITION APPLY

This guarantee cover damage that occurs in transit,such as motor does not work,battery does not supply power etc.

The scooter is guaranteed to be free for a period of 1 year from the date of purchase.

NOTE:Warranty will not be provided in following circumstances

- 1)Out shells that are approved by the customer before delivery are not included in these warranty terms.
- 2)Consumable and quick-wear parts are not covered by warranty:LED lights,tires and tubes,the whole set of braking system,brake cable,plastic parts,and covers,etc.
- 3)All the artificial damage such as wading,access not appropriate power,using inappropriate accessories.

One of the following cases shall not in warranty, but there will be a reasonable repairing fee.

- 1)Beyond the warranty period;
- 2)The serial number or labels on major parts removed or destroyed by consumers ;
- 3)The details on warranty card does not match with the physical identification of goods or be altered;
- 4)The damaged because of not use referring to the product specification requirements and unreasonable maintenance.
- 5)The damaged was caused by non-commitment warranty Party A who are unreasonable disassemble.