



Read Me First

Dear user,

Thanks for purchasing this electric scooter. This electric scooter is environmentally-friendly high-tech product as well as an ideal means of electric scooter that features excellent shock absorption, streamlined appearance, portability and flexibility, good riding comfortably, high safety and reliability. For better understanding of the characteristics, technical parameters, correct use, maintenance and precautions of this scooter, see to it that you read this user manual carefully before using it.

1. DO NOT use the scooter before learning about its performance
2. DO NOT lend your scooter to anyone who cannot operate it, juveniles, pregnant women, or the disabled.
3. DO NOT arbitrarily discard spent batteries to avoid pollution to the environment; see to it that they are handled by your distributor or service provider.
4. For sake of your own safety, please check whether the braking system functions well before using the scooter.
5. For safety reasons, DO NOT cover the charge and keep it well ventilated during charging.
6. When replacing a failed tire, note that the fasteners of the wheel are tightened in case of a secondary accident due to wheel looseness.
7. For safe use of this product, DO NOT arbitrarily disassembles or modifies the circuit or parts of the scooter.
8. In case of any abnormality, power the scooter off to stop it in order to ensure your safety.
9. Images included in this user manual are intended for operation demonstration and may not be used for the basis of product inspection.
10. In the event that images included in this user manual might not be in conformity with the real product, the real product shall prevail.
11. Product performance and configuration that man be improved from time to time are subject to change without prior notice.

Enjoy your riding!

Content

1. Read ME First	-----	01
2. Content	-----	02
3. Asssembly Diagram	-----	03-04
4. Proformance	-----	05
5. Structural Diagram	-----	06
6. Improper Use Cases	-----	07-08
7. Legal statement	-----	09-10
8. Dashboard Instructions	-----	11-12
9. Parameters	-----	13
10. How to Use and Precautions	-----	14-15

Assemlay Diagram

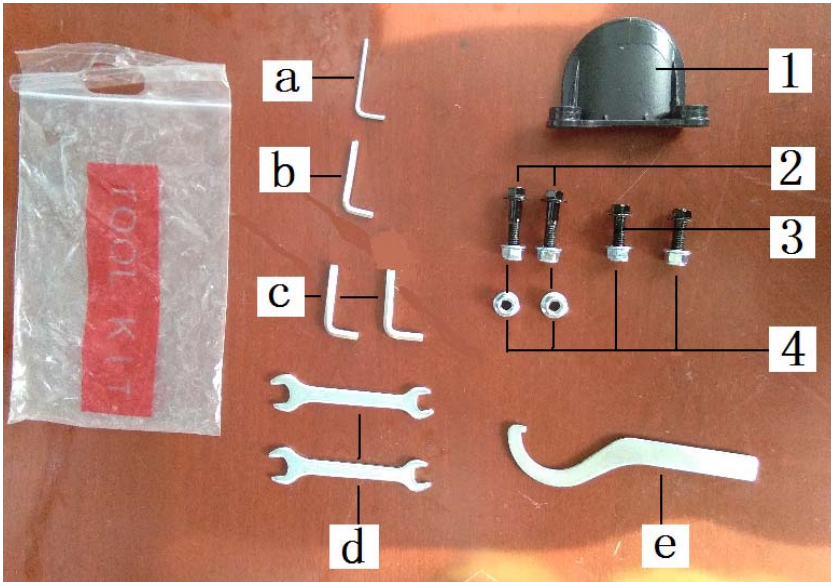

Tools:

- a---2.5#Allen Key 1pcs
- b---4#Allen Key 1pcs
- c---5#Allen Key 2pcs
- d---10-12#Open End Wrench 2pcs
- e---Hook Spanner Wrench 1pcs

Parts:

- 1---Front Fender
- 2---Flange Bolt M8X35, 2pcs
- 3---Flange Bolt M8X25, 2pcs
- 4---Self-Locking Nut M8, 6pcs

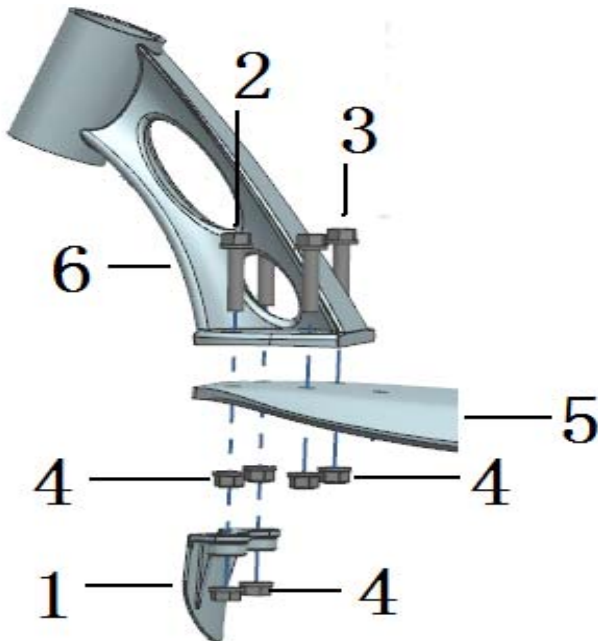

Using Tools:

- 10-12#Open End Wrench 2pcs

Parts:

- 1---Front Fender
- 2---Flange Bolt M8X35, 2pcs
- 3---Flange Bolt M8X25, 2pcs
- 4---Self-Locking Nut M8, 6pcs
- 5---Aluminum Borad
- 6---Connection Bridge

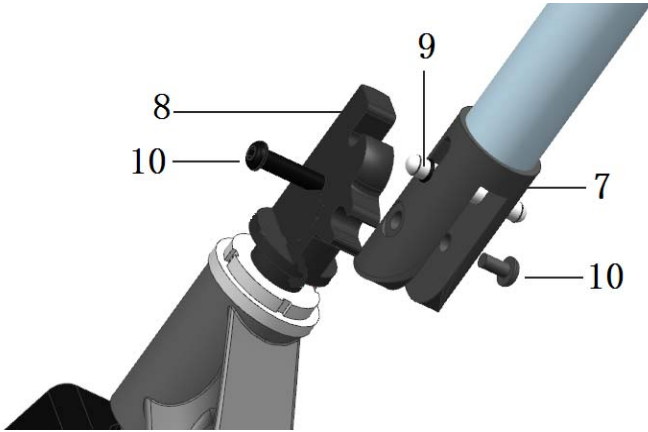

Using Tools:

5#Allen Key 2pcs

Parts:

7---Folder (Up)

8---Folder (Down)

9---Folder Pin

10---Flange Bolt ϕ 8XM6X36

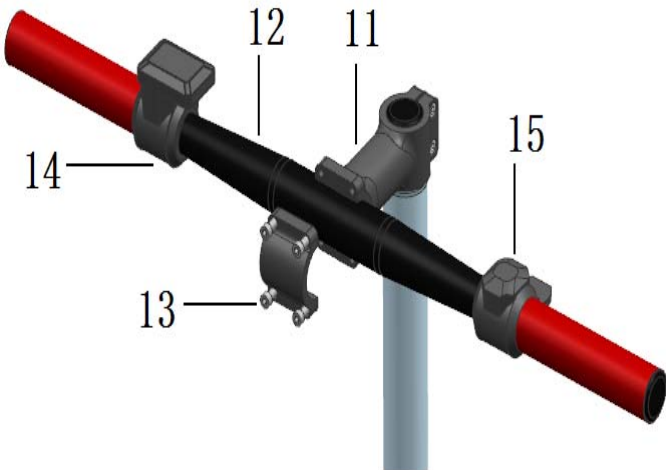

Using Tools:

4#Allen Key 1pcs

Parts:

11---Stem

12---Handebar

13---Bolt M5X16, 4pcs

14---Display

15--- Power Off Switch

Proformace

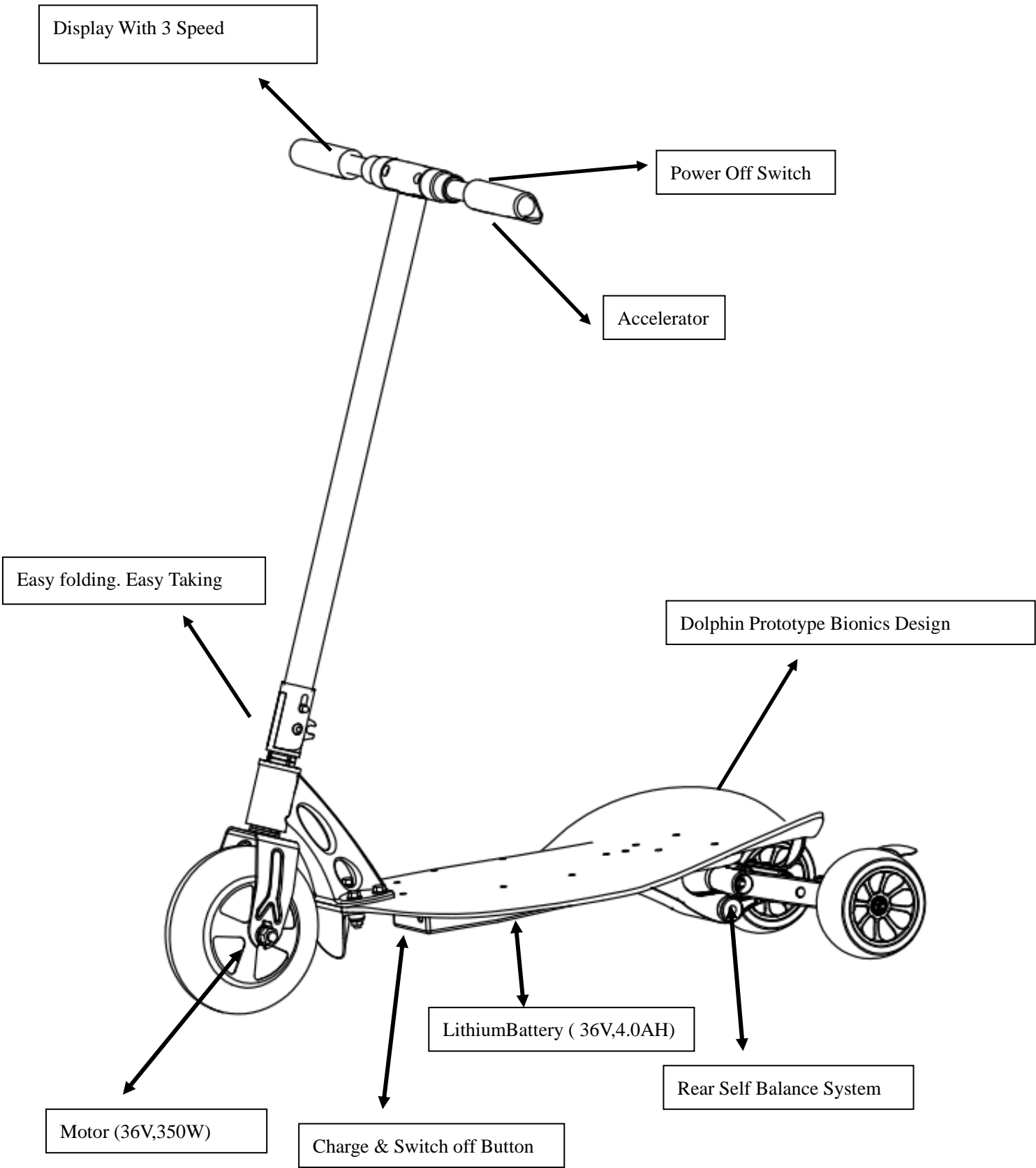

Structural Diagram

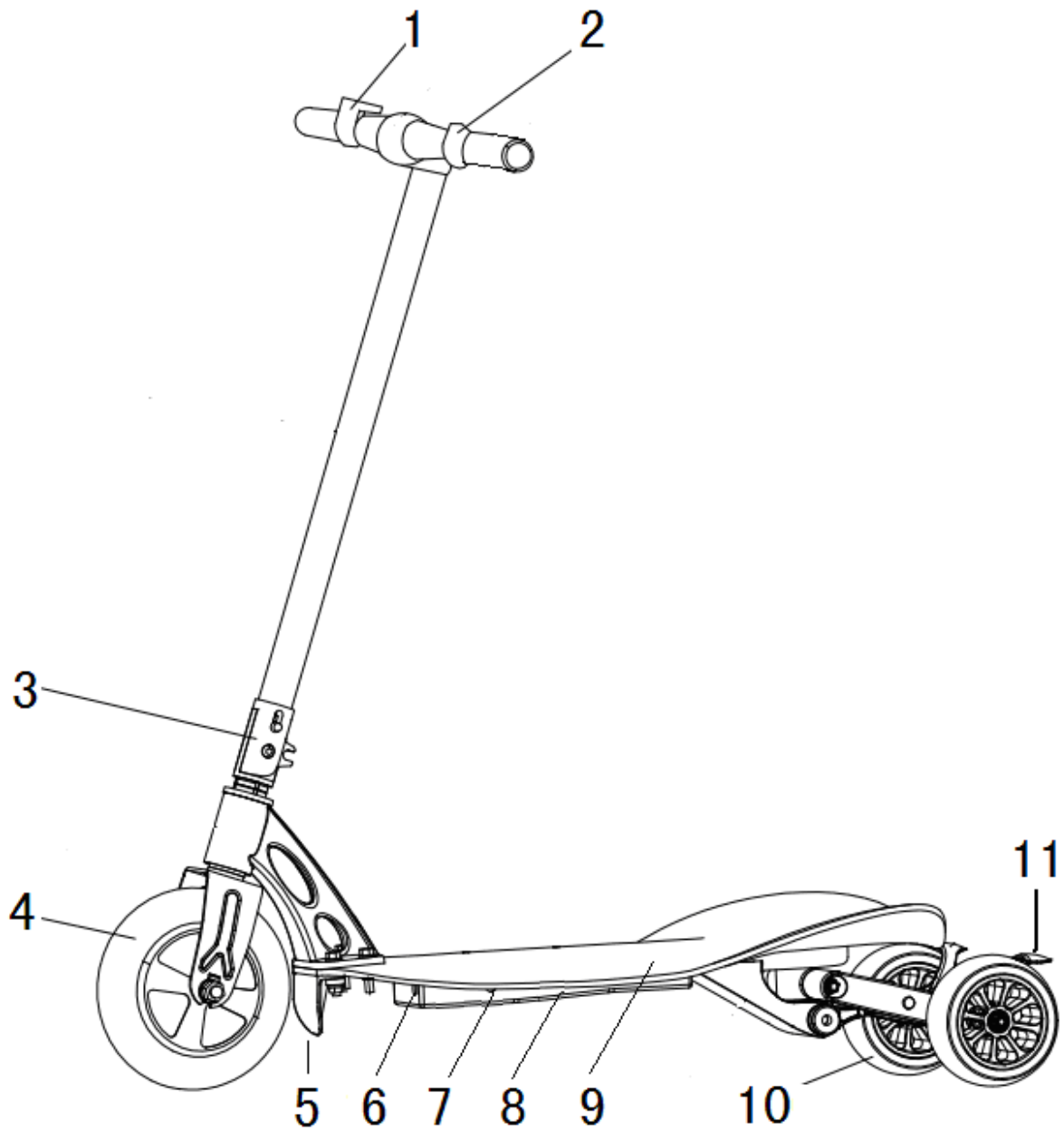

1	Accelerator	2	reducer	3	Folders	4	Motor wheel
5	Front fender	6	Charging mouth	7	Button switch	8	Battery box
9	Pedal	10	Rear wheel	11	Rear fender		

Improper Use Cases

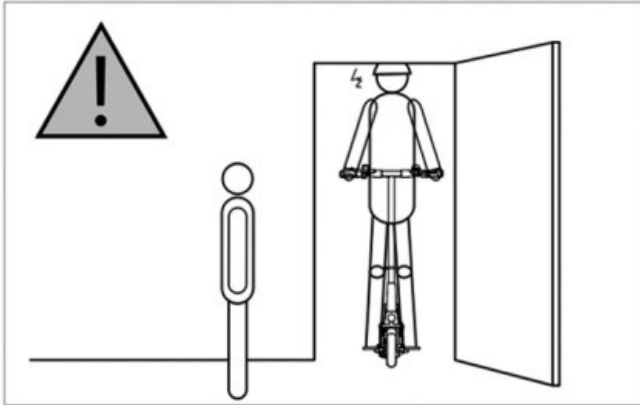

Watch out for overhead obstacles, such as the door frame or the elevator.

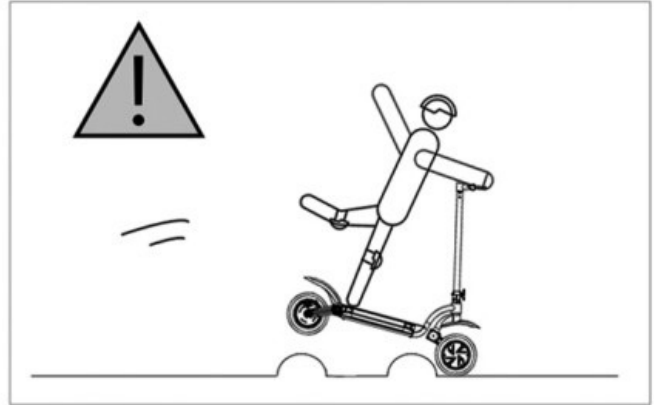

DO NOT pass irregular surfaces at a high speed.

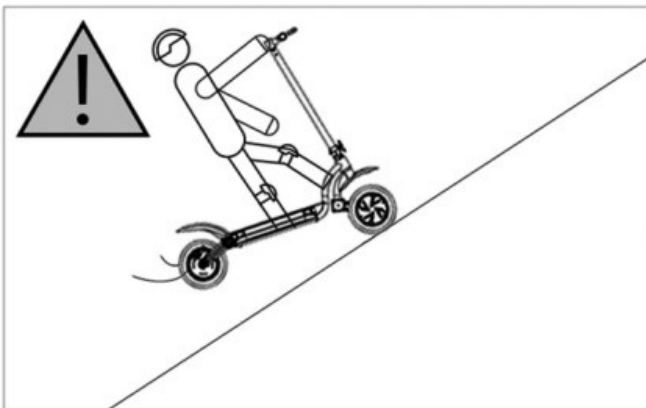

DO NOT ride on slopes larger than 20° for extended periods of time.

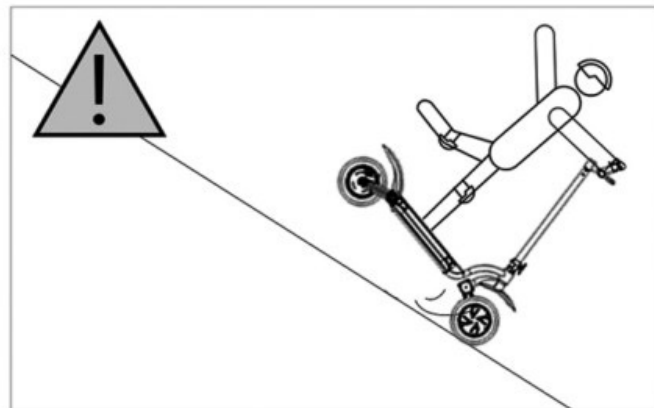

DO NOT accelerate while riding downhill. DO NOT use the front brake while riding at a high speed.

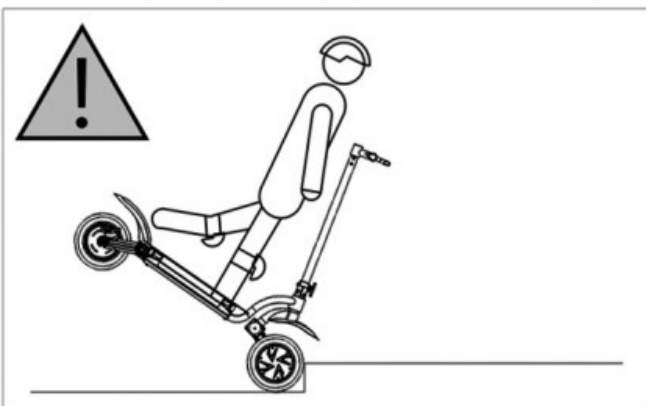

DO NOT go up/down steps or cross obstacles with the scooter.

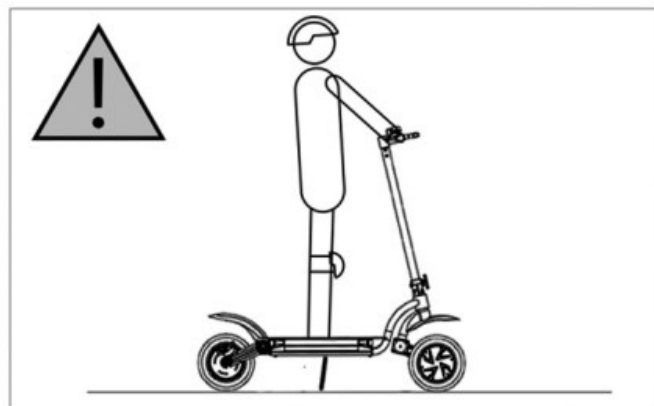

DO NOT stand on the footboard after the scooter is powered off and stops.



DO NOT ride in the rain

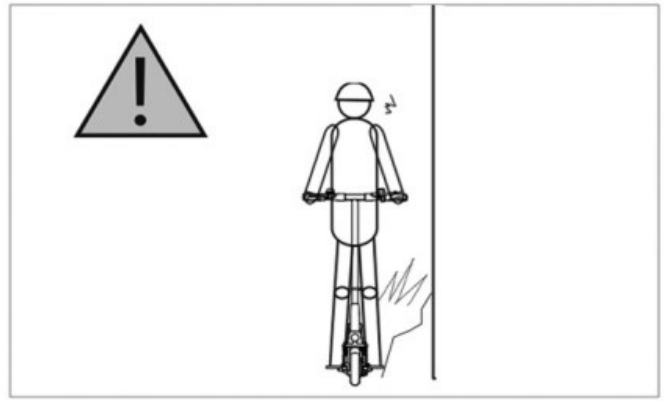

Avoid obstacles while riding

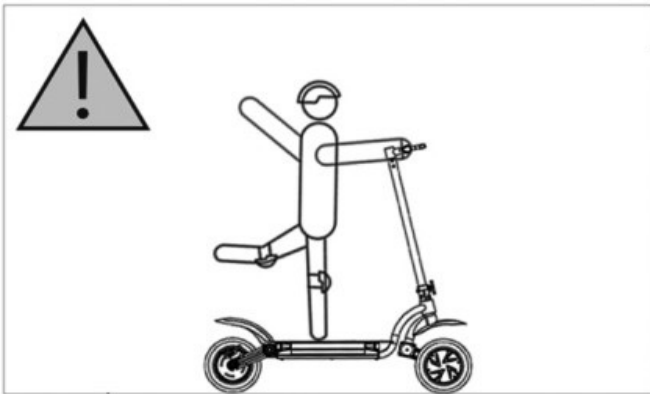

DO NOT ride with a single hand or foot

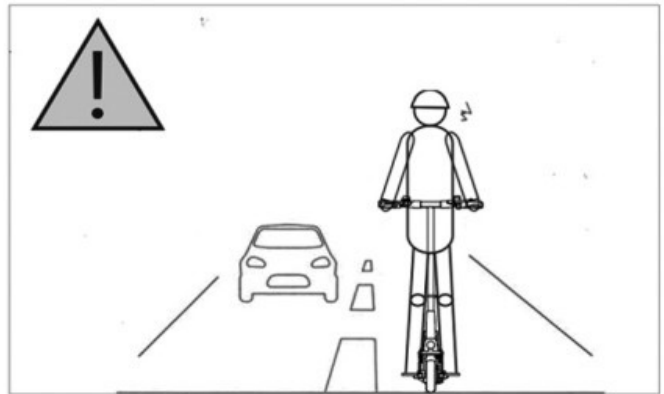

DO NOT ride on motor way

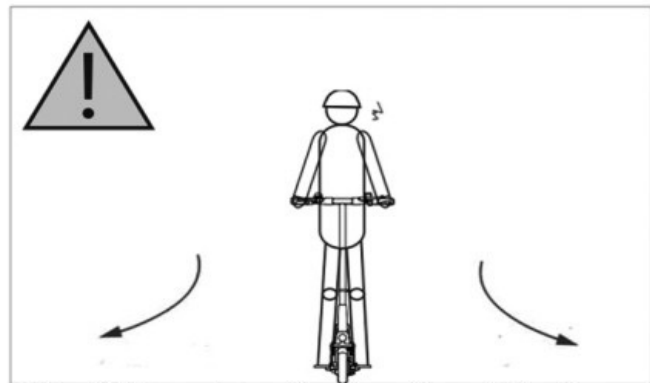

DO NOT rotate the handle violently while riding at a high speed

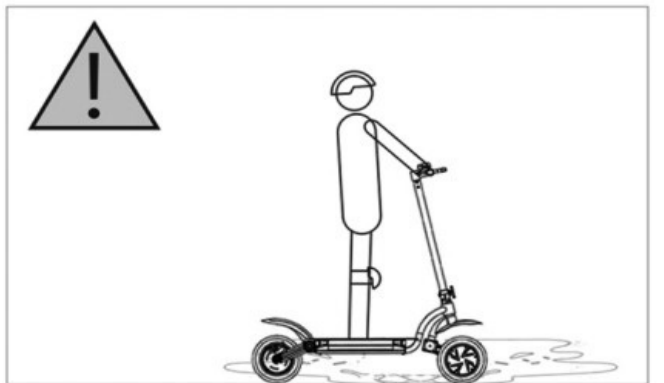

DO NOT ride in water deeper than 2cm



DO NOT ride with both hands leaving the handle

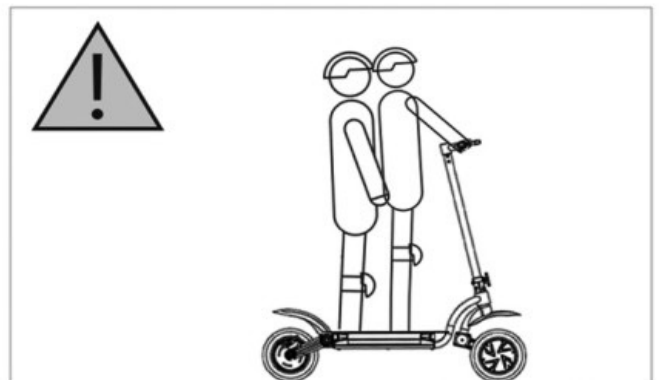

DO NOT carry passenger(s)

Legal statement

As you have been acquainted with this scooter with more riding skills, please:

1. Read this user manual carefully before using it for practice.
2. Those who haven't read this user manual carefully in advance are not allowed to use this scooter.
3. DO NOT charge when the slot/shock is wet. Charge the scooter with correct power supply (100~240V/50~60Hz). While charging, keep children, pet or inflammables away from the scooter.
4. Install all the parts of this scooter properly following this user manual, otherwise improper installation may lead to control failure, collision or crash. Turn the power off before installation, repair or maintenance.
5. DO NOT place the battery unit in the environment where temperature is higher than 50°C or lower than -20°C.
6. In the event that the battery unit is damaged or hot, smells abnormally, or smokes, stop using it immediately and keep it away from other objects.
7. DO NOT open or disassemble the battery unit that contains harmful substance.
8. The scooter that has been fully charged may stand by for 120-180 days, whereas the one that is under charged may stand by for 30-60 days. Please notice the stand-by time of your scooter in case of unrecoverable damages to the battery unit due to untimely charging.
9. It is prohibited that you practice outdoor until you have been sufficiently familiar with the operation methods of the scooter. The more times you practice, the safer you can ride in new circumstances. Please note the essentials of practice: what you need first is primary practice in an obstacle-free area ($\geq 10\text{m} \times 10\text{m}$) to practice riding forward, making turns and stopping. Keep yourself relaxed while practicing. When you practice for the first time, it is recommended that you do this with the guidance of an experienced person or coach. Try to practice passing narrow areas, turning and stopping as your practice deepens. You are not allowed to ride on normal roads until you are able to control your scooter to pass a narrow area precisely and have simulated all types of terrains. You may have a different experience every time you have your electric scooter upgraded. Therefore, see to it that you practice in the same obstacle-free area as if you were a beginner for the first time you ride the scooter after upgrading.
10. Check the scooter carefully to make sure there isn't any loose part or damage before riding it.
11. Watch the crossing carefully before or during you ride your scooter or when you stop it to avoid any unnecessary damage to yourself, or object, people or small animals around you.
12. In the event that the tire works abnormally during riding, please stop and examine it in case of danger.
- 13 DO NOT ride in high-heeled shoes.
14. DO NOT dip the battery and scooter frame into water, expose it to storms or ride in the rain for a long time. DO NOT clean the scooter with powerful water stream or a high-pressure water gun to avoid waterlog in the charging port. In the event that your scooter is exposed to storms for a long time, please stop using it immediately; wipe it with a piece of dry soft cloth, and contact after-sale service personnel. Do not do anything other than wiping the scooter in case of voided warranty due to any misconduct.
15. In the event of low battery, the scooter may not run at high speed continuously as

expected. You may charge it for better riding experience.

16. Note terrain changes while riding, such as road and grassplot.

17. Be careful while turning! You may lose control at fast turning.

18. DO NOT risk passing the abrupt slope, uneven surface or other unfamiliar terrains.

19. DO NOT ride on the motor way or run a red light. Follow traffic rules and give way to pedestrians.

20. Strengthen your awareness of self-protection while riding. Watch out for yourself, vehicles and pedestrians.

21. Please ride the bikeway or at the edge of local government.

22. It is absolutely prohibited that you are towed by another vehicle with hand(s) on the vehicle while riding.

23. DO NOT stunt while riding.

24. DO NOT ride your scooter in way of the following situations: severe weather, poor visibility, at dawn, in the evening, in the dark, or exhaustion since an accident is more likely to occur in event of any of these situations.

25. As you are higher while standing and riding helmeted on the scooter, watch out while you are riding indoors, at the door or near any other place that is close to your head.

26. DO NOT wear loose clothes while riding in case they are entangled into the wheel.

27. DO NOT carry a passenger while riding. This scooter is designed for a single rider. It is prohibited that it is ridden by two or by anyone carrying a baby.

28. DO NOT use your scooter to go upstairs/ downstairs, ride it into the elevator or cross the revolving door.

29. DO NOT ride on the highway unless it is allowed by local laws and regulations.

30. DO NOT use your scooter as a cargo carrier.

31. When approaching or crossing an intersection, motor way, turning or passing by a door/gate, please slow down and give way to the pedestrians, bicycles and motor vehicles.

32. DO NOT ride your scooter when you fall ill or cannot fully comply with the instructions specified in this user manual, or after you take medicine or drink alcohol.

33. To avoid distraction while riding, DO NOT make phone calls or do anything that might distract you so that you are able to concentrate yourself on traffic.

34. Age requirement: 14-50 years old. Tips for parents: as a parent or a guardian, you are responsible for your child's activities and safety. It is highly recommended that your child is kept away from the scooter.

35. Avoid abrupt braking, especially on smooth surfaces since this may lead to loss of traction and increase the possibility of you falling off from the scooter.

36. Any modification to this scooter may undermine your safety of riding. Any unauthorized modification to this scooter is prohibited.

37. You are obliged to be informed of and observe the laws of the place where you are located. This statement applies to the laws of the people's republic of China.

We assume no responsibility for any claim, liability or loss incurred by or possibly incurred by consumer's violation of the clauses of the legal statement above. The rider by himself/herself shall undertake the responsibility for any unpredictable or inevitable risk during riding.

You are free to continue to use our product if you accept the clauses set forth in our legal statement or return it if otherwise.

Please make sure the product and its package areas intact they don't impact resale before returning the product to us.

Dashboard Instructions

Before you use please read the instruction following

1. Configuration





2. The keys

There has three key on the meter,, -power、-speed up、-slow down。

3. Operation

Press the  for a while to turn on the meter , battery 、 speed shows according to the electric vehicle running status, TRIP and ODO shows according to the different function



The meter would be cut off the power automatically if the meter has no signal input within three minutes

Press the , the meter will shows TIME, TRIP, ODO, DST, CHA, VOL. TIME-Riding times, TRIP-trip A (press  for awhile can clear the trip A data), ODO-trip odometer , DST-remaining mileage (according to the Li-battery), CHA-recharge times (some can not shows) , VOL-current voltage (press speed up or slow down, change to the assistant power(1st-fast speed, 2st-middle, 3st-slow speed)









Down handle, increasing speed, loosen handle, slow down.

Press  for a while, the power would be turn off when the meter works.





4. Parameter setting

Press  +  for a while can enter setting. Then press , The meter can appear P0、 P1、 P2、 P3、 P4、 P5、 P6、 P7, you can use the different parameter setting. P0-undervoltage setting, P1-wheel diameter setting, P2-number of Pole pair setting, P3-speed signal choose, P4-kilometer and mile choose, P5-nonzero starting and zero starting(some without),

P6-cruise(some without), P7-hard starting and soft starting(some without).

- a) When display shows P0, it's under voltage setting, press  or  to modify setting.
- b) When display shows P1, it's wheel diameter setting, press  or  to modify setting (mile) .
- c) When display shows P2, it's number of pole pairs setting, press  or  to modify setting.
- d) When display shows P3, it's speed signal choose, set 1, choose motor holler signal velocities; set 0, choose external speed signal.
- e) When display shows P4, it's kilometer/mile choose, set 0 is kilometer, set 1 is mile.
- f) When display shows P5, it's non-zero starting and zero starting , set 0 is zero starting, set 1 is non-zero starting(some without).
- g) When display shows P6, it's cruise and no cruise, set 0 is no cruise, set 1 is cruise (some without).
- h) When display shows P7, it's hard starting and soft starting, set 0 is soft starting ,set 1 is hard starting(some without).
- i) When led shows P8, it means can increase the speed to max speed, determined by percentage
- j) Press  +  for awhile can exit the system, also can keep the setting data.

5. Malfunction setting

When electric scooter is not working , the meter can shows which part maybe have problem. There are brake system 、 motor trouble 、 handle turner trouble 、 controller trouble  and so on.

6. Wire, lead wire abut upon the controller

Parameters

	parameter	Specification(36V)	Specification(36V)
performance	Maximum speed	25km/h	20km/h
	Maximum load	70kg	50kg
	Net weight	14kg	13.5kg
	Fold size	960mm*600mm*390mm	960mm*600mm*390mm
	Full size	960mm*600mm*1080mm	960mm*600mm*980mm
	Inner box size	1060mm*340mm*200mm	960mm*340mm*200mm
	Carton size	1080mm*360mm*425mm	980mm*360mm*425mm
	Handlebars adjust height	/	/
	Renewal	10km	8km
	Brake Distance	8m	8m
	Age	14-40	10-16
Part	Motor power	350W	250W
	Motor rating	36V	36V
	Battery rating	36V	36V
	Battery capacity	4.0Ah	4.0Ah
	Charger input voltage	AC100-240V~50/60Hz	AC100-240V~50/60Hz
	Charger output voltage	DC 36-42V	DC 36V
	Charger output current	2A	2A
	Charge time	4h	4h

How to Use and Precautions

(1) Safe use

1. In the benefit of you and the others, please read this user manual carefully before using the scooter. DO NOT use it until you have adequate knowledge about its performance. DO NOT lend it to whoever is unfamiliar with the operation of this scooter.
2. Please observe traffic rules consciously. Ride your scooter in the non-motor lane. DO NOT carry a passenger.
3. Please brake in advance to ensure the scooter stops within an appropriate braking distance.
4. DO NOT ride in waterlogged area.

(2) Check before use

1. Check whether the wheels rotate well.
2. Check whether the battery has been fully charged.
3. Check whether the braking system works flexibly and make sure that the power is cut off when braking.
4. Check whether the folding mechanism has been locked up.

(3) operation

1. Start the button switch on the left side of the battery box and then turn on the power switch on the meter. Then regulate the speed threshold to an appropriate gear, press the speed regulating handle slowly and rotate it to an appropriate position based on speed to keep the scooter running at a safe speed.
2. Please keep the two feet one behind the other to make the human body in the most appropriate position while riding.
3. Avoid frequent braking or startup while riding, which helps prolong the battery' service life. When decelerating, release the speed regulating handle until motor power is cut off.

(4) Use of battery and precautions

1. The battery unit consists of sealed li-ion batteries that feature long service life and leakage-proof sealed structure. Considering the fact that the battery unit has been in storage for a long time since it is manufactured, please make sure it is fully charged before using the scooter for the first time. Recharge the battery unit timely in the event of low battery during riding. Have the battery unit fully charged before long storage, and charge/discharge once a week if

possible.

2. Using the dedicated charger only, otherwise battery's service life might be undermined.

Battery indication: observe battery level while riding since the observed result in the stationary state is inaccurate. Charge the scooter timely in the event of low battery indication.

3. DO NOT touch the metal contacts on the charger socket with hand or metal that may cause short-circuit in case of accidents.

(5) Use of charger and precautions

1. Plug the charge's out put terminal into charging hole on the battery unit, then connect the charger to AC 100-200V/50-60HZ power supply and make sure charging indicator is on. To avoid damage to the controller, power the scooter off during charging time that can last 3 hours.

2. Trip distance can decline at a low temperature.

3. Charging mode: it is recommended that the scooter be charged once a day if possible. The whole charging process is automatically controlled: when the charging indicator turns to green, it means the battery unit has been fully charged and is in a floating charge state. Floating charging doesn't cause any damage to batteries. At this point, it is unnecessary to stop charging since very little energy is consumed during floating charge.

4. In case of damages, avoid violent bump or impact when using, shipping or carrying the charger. Keep liquid or metal filings away from the charger in case it is short-circuited or damaged.

5. DO NOT place inflammables under the charger because heat is generated while it is working. It is prohibited that the charger is covered or surrounded by anything so as not to affect heat dissipation. The charger shall be used in a well-ventilated place. In the event that there is peculiar smell, smoke, or excessive temperature (higher than 65 °C) from/on the charger, stop charging immediately and have it repaired in the maintenance department.

6. In the event that the charging indicator doesn't turn green for long time (generally longer than 10 hours) while the charger is in the charging mode all the time, particularly along with a high battery temperature due to charger failure, battery damage or low voltage, please stop charging immediately and have the scooter repaired in the maintenance department.

7. For sake of adaptability between the charger and battery, please DO NOT charge your scooter using chargers other than the dedicated one.

(6) Routine maintenance and precautions

1. Rotate the speed regulating handle slowly rather than violently.

2. DO NOT washing the scooter directly to avoid short-circuit of electric/electronic parts due to moisture/water.

3. For safety sake, turn the main power switch off when parking the scooter.

4. Replace for a new brake pad when 1/3 of it has been worn out and braking effect is impacted.

5. Remove the contaminants adhered to brake disc or other surfaces.

6. Check whether or not the electric part of power-cut brake is well connected and whether the fasteners are loose. Make timely adjustment if any.

7. Make periodical examinations and maintenance, generally once every six months.